

Data Sheet



Article number: 12512600025100

Description: KLEE-coil 512 600 025.100
M2,5 Hardened, zinc-pl.

Measures

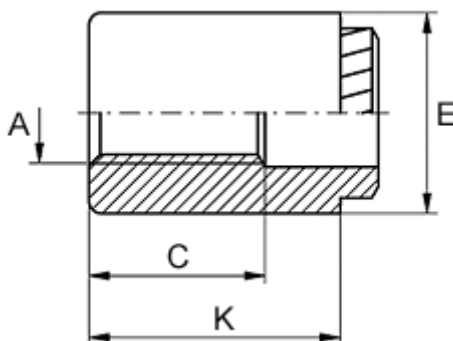

Female thread A	= M2,5
Height K	= 12
Hole diameter +0.1	= 4.2
Min distance to edge	= 2.4
Min material thickness	= 1.5
Outer diameter E	= 6
Thread length	= 9